

Absolute encoders - bus interfaces

Solid shaft $\varnothing 11$ mm with EURO flange B10 or housing foot B3

Profibus DPV0 or DPV2 / 13 bit ST / 16 bit MT / Speed switch

PMG10 - Profibus DP



PMG10 - picture similar

Features

- Magnetic sensing method
- Function display via LEDs
- Multiturn sensing with Energy Harvesting technology, without gear or battery
- Two-sided bearing system with hybrid bearings
- Special protection against corrosion C5-M

Optional

- Integrated speed switch
- Additional output incremental with zero pulse

Technical data - electrical ratings

Voltage supply	10...30 VDC
Short-circuit proof	Yes
Consumption w/o load	≤ 200 mA
Initializing time	≤ 500 ms after power on
Interface	Profibus-DPV0/V2
Function	Multiturn
Transmission rate	9.6...12000 kBaud
Device address	Rotary switches in bus connecting box
Steps per revolution	8192 / 13 bit
Number of revolutions	65536 / 16 bit
Additional outputs	Square-wave TTL/HTL, TTL/RS422
Sensing method	Magnetic
Interference immunity	EN 61000-6-2
Emitted interference	EN 61000-6-3
Programmable parameters	Steps per revolution Number of revolutions Preset, scaling, rotating direction
Diagnostic function	Position or parameter error
Status indicator	DUO-LED (bus connecting box) 4 LEDs in device back side
Approval	CE

Technical data - electrical ratings (speed switches)

Switching accuracy	± 2 % (or 1 Digit)
Switching outputs	1 output (Open collector, solid state relay on request)
Output switching capacity	30 VDC; ≤ 100 mA
Switching delay time	≤ 20 ms

Technical data - mechanical design

Size (flange)	$\varnothing 115$ mm
Shaft type	$\varnothing 11$ mm solid shaft
Flange	EURO flange B10 Housing foot B3
Protection DIN EN 60529	IP 66/IP 67
Operating speed	≤ 6000 rpm
Range of switching speed	ns (off) = ± 2 ...6000 rpm, factory setting 6000 rpm
Operating torque typ.	10 Ncm
Rotor moment of inertia	1 kgcm ²
Admitted shaft load	≤ 450 N axial ≤ 650 N radial
Materials	Housing: aluminium alloy Shaft: stainless steel
Corrosion protection	IEC 60068-2-52 Salt mist for ambient conditions C5-M (CX) according to ISO 12944-2
Operating temperature	-40...+85 °C
Relative humidity	95 % non-condensing
Resistance	IEC 60068-2-6 Vibration 30 g, 10-2000 Hz IEC 60068-2-27 Shock 400 g, 1 ms
Weight approx.	2.7 kg (depending on version)
Connection	Bus connecting box Terminal box incremental

Absolute encoders - bus interfaces

Solid shaft \varnothing 11 mm with EURO flange B10 or housing foot B3 Profibus DPV0 or DPV2 / 13 bit ST / 16 bit MT / Speed switch

PMG10 - Profibus DP

Part number

PMG10

	-S			.	1			.	3			00			.	A
--	----	--	--	---	---	--	--	---	---	--	--	----	--	--	---	---

Additional output*

- 0 Without
 - 5 1024 ppr TTL/HTL (Vin=Vout), 6 channels, electrically isolated
 - 6 1024 ppr TTL/RS422, 6 channels
- See also table "Additional output"

Resolution multiturm

- 0 Without
- 6 16 bit

Voltage supply / interface

- P0 10...30 VDC, Profibus-DPV0
- P2 10...30 VDC, Profibus-DPV2

Connection

- 5 1x bus connecting box with 3 cable glands M16, radial
- 3 1x bus connecting box with 3 connectors M12, radial
- F 1x bus connecting box with 3 cable glands M16, radial + 1x terminal box with 1 cable gland M20, radial
- G 1x bus connecting box with 3 connectors M12, radial + 1x terminal box with 1 cable gland M20, radial

Shaft diameter

- 1 \varnothing 11 mm with key 4 mm

Protection

- D IP 66 and IP 67, optimized for dusty environments
- L IP 66 and IP 67, optimized for oily and wet environments

Flange

- H EURO flange B10, shaft insulation hybrid bearing
- A Housing foot B3, shaft insulation hybrid bearing

Speed switch*

- Without
- D With speed switch (***)
(Standard: Open collector, solid state relay on request)

* Only for connection with 1x bus connecting + 1x terminal box (F or G)

** Please specify the exact switching speed in addition to the part number (factory setting).

Absolute encoders - bus interfaces

Solid shaft $\varnothing 11$ mm with EURO flange B10 or housing foot B3

Profibus DPV0 or DPV2 / 13 bit ST / 16 bit MT / Speed switch

PMG10 - Profibus DP

Part number - tables

Additional output*

0 (Without)
Q (8192 ppr TTL/HTL (Vin=Vout), 6 channels, electrically isolated)
P (8192 ppr TTL/RS422, 6 channels)
G (5000 ppr TTL/HTL (Vin=Vout), 6 channels, electrically isolated)
H (5000 ppr TTL/RS422, 6 channels)
K (4096 ppr TTL/HTL (Vin=Vout), 6 channels, electrically isolated)
J (4096 ppr TTL/RS422, 6 channels)
7 (3072 ppr TTL/HTL (Vin=Vout), 6 channels, electrically isolated)
8 (3072 ppr TTL/RS422, 6 channels)
9 (2048 ppr TTL/HTL (Vin=Vout), 6 channels, electrically isolated)
4 (2048 ppr TTL/RS422, 6 channels)
5 (1024 ppr TTL/HTL (Vin=Vout), 6 channels, electrically isolated)
6 (1024 ppr TTL/RS422, 6 channels)
1 (512 ppr TTL/HTL (Vin=Vout), 6 channels, electrically isolated)
2 (512 ppr TTL/RS422, 6 channels)

Accessories

Mounting accessories

K 35	Spring washer coupling for solid shaft $\varnothing 6...12$ mm
K 50	Spring washer coupling for solid shaft $\varnothing 11...16$ mm
K 60	Spring washer coupling for solid shaft $\varnothing 11...22$ mm

Absolute encoders - bus interfaces

Solid shaft $\varnothing 11$ mm with EURO flange B10 or housing foot B3

Profibus DPV0 or DPV2 / 13 bit ST / 16 bit MT / Speed switch

PMG10 - Profibus DP

Profibus-DP V0 - Terminal assignment

View A¹⁾ - View inside bus connecting box

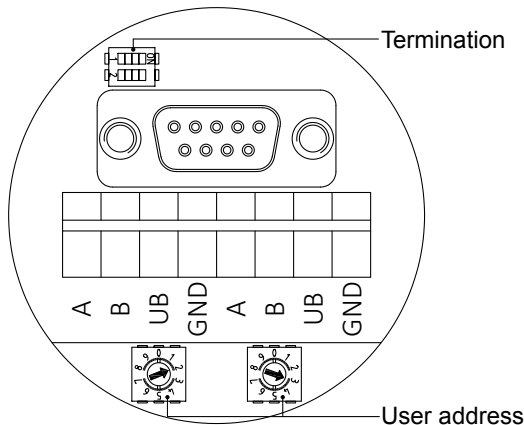

View A¹⁾ - View into connector „Voltage supply“

male	Connection	Description
1	UB	Voltage supply 10...30 VDC
3	GND	Ground connection for UB

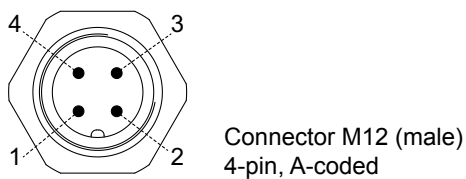

View A²⁾ and A³⁾ - View into connector „Data transmission“

male / female	Connection	Description
2	A	Negative serial data transmission
4	B	Positive serial data transmission

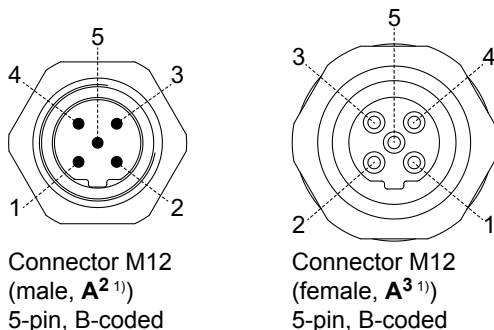

Terminals of the same significance are internally connected and identical in their functions. Max. load on the internal terminal connections UB-UB and GND-GND is 1 A each.

Profibus-DP V0 - Features

Bus protocol	Profibus-DP V0
Profibus-Features	Device Class 1 and 2
Data Exch. functions	Input: Position value Output: Preset value
Preset value	The „Preset“ parameter can be used to set the encoder to a pre-defined value that corresponds to a specific axis position of the system.
Parameter functions	Rotating direction: The relationship between the rotating direction and rising or falling output code values can be set in the operating parameter. Scaling: The parameter values set the number of steps per turn and the overall resolution.
Diagnostic	The encoder supports the following error messages: - Position error
Factory setting	User address 00

Profibus-DP V0 - Termination

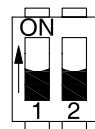

both ON = final user
both OFF = user xx

Profibus-DP V0 - User address

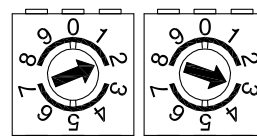

Defined by rotary switch.
Example: User address 23

¹⁾ See dimensions

Absolute encoders - bus interfaces

Solid shaft $\varnothing 11$ mm with EURO flange B10 or housing foot B3

Profibus DPV0 or DPV2 / 13 bit ST / 16 bit MT / Speed switch

PMG10 - Profibus DP

Profibus-DP V2 - Terminal assignment

View A¹⁾ - View inside bus connecting box

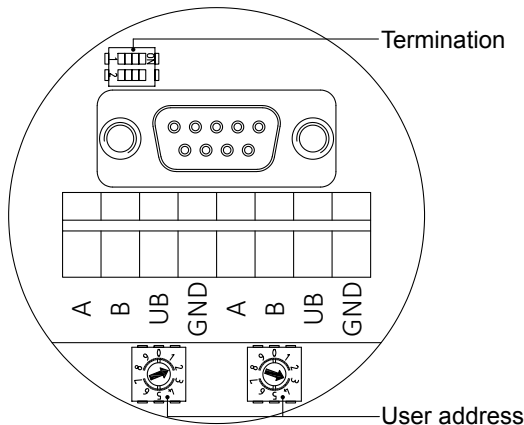

View A¹⁾ - View into connector „Voltage supply“

male	Connection	Description
1	UB	Voltage supply 10...30 VDC
3	GND	Ground connection for UB

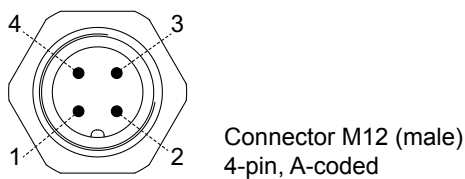

View A²⁾ and A³⁾ - View into connector „Data transmission“

male / female	Connection	Description
2	A	Negative serial data transmission
4	B	Positive serial data transmission

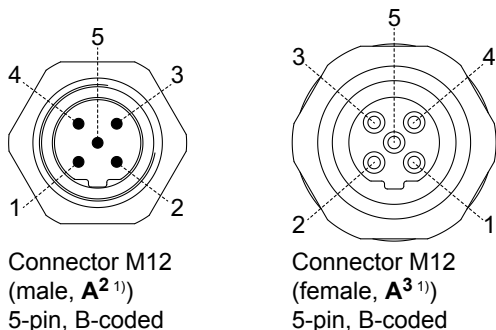

Terminals of the same significance are internally connected and identical in their functions. Max. load on the internal terminal connections UB-UB and GND-GND is 1 A each.

Profibus-DP V2 - Features

Bus protocol	Profibus-DP V2
Profibus-Features	Device Class 3 and 4
Data Exch. functions	Input: Position value Output: Preset value
Preset value	The „Preset“ parameter can be used to set the encoder to a pre-defined value that corresponds to a specific axis position of the system.
Parameter functions	Rotating direction: The relationship between the rotating direction and rising or falling output code values can be set in the operating parameter. Scaling: The parameter values set the number of steps per turn and the overall resolution.
Diagnostic	The encoder supports the following error messages: - Position error
Factory setting	User address 00

Profibus-DP V2 - Termination

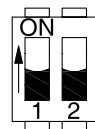

both ON = final user
both OFF = user xx

Profibus-DP V2 - User address

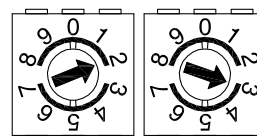

Defined by rotary switch.
Example: User address 23

¹⁾ See dimensions

Absolute encoders - bus interfaces

Solid shaft $\varnothing 11$ mm with EURO flange B10 or housing foot B3

Profibus DPV0 or DPV2 / 13 bit ST / 16 bit MT / Speed switch

PMG10 - Profibus DP

Speed switch / additional output incremental - Terminal significance

Ub ²⁾	Voltage supply
0V ²⁾	Ground
A+ ²⁾	Output signal channel 1
A- ²⁾	Output signal channel 1 inverted
B+ ²⁾	Output signal channel 2 (offset by 90° to channel 1)
B- ²⁾	Output signal channel 2 inverted
R+ ²⁾	Zero pulse (reference signal)
R- ²⁾	Zero pulse inverted
nE+	System OK+ / error output
nE-	System OK- / error output inverted
SP+ ³⁾	DSL_OUT1 / speed switch (Open collector, solid state relay on request)
SP- ³⁾	DSL_OUT2 / speed switch (0V, solid state relay on request)
dnu	Do not use

Speed switch / additional output incremental - Terminal assignment terminal box

View B¹⁾

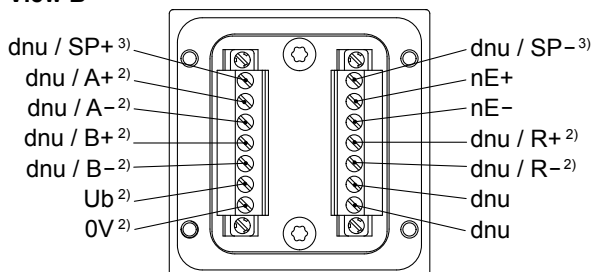

Additional output incremental - Trigger level

Trigger level	TTL/RS422
High / Low	≥ 2.5 V / ≤ 0.5 V
Transmission length	≤ 550 m @ 100 kHz
Output frequency	≤ 600 kHz
Trigger level	TTL/HTL (Vin = Vout)
High / Low	≥ 2.5 V / ≤ 0.5 V (TTL) $\geq U_b - 3$ V / ≤ 1.5 V (HTL)
Transmission length	≤ 550 m @ 100 kHz (TTL) ≤ 350 m @ 100 kHz (HTL)
Output frequency	≤ 600 kHz (TTL); ≤ 350 kHz (HTL)

Electrically isolated:

The output TTL/HTL (Vin = Vout) at the additional output incremental is electrically isolated and requires a separate power supply.

¹⁾ See dimensions

²⁾ Additional output incremental (option)

³⁾ Speed switch (option)

Additional output incremental - Output signals

Version with additional output incremental at positive rotating direction¹⁾

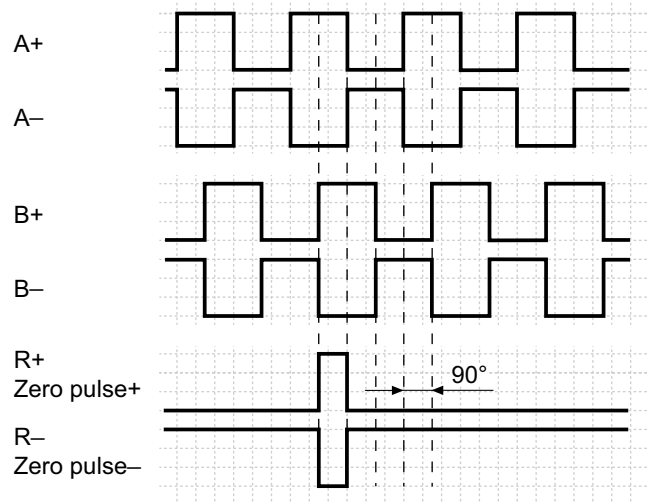

Speed switch - Switching characteristics

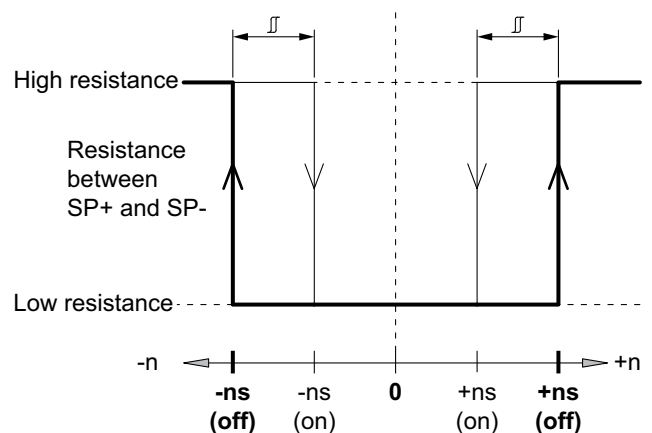

n = Speed

+ns (off) = Switch-off speed at shaft rotation in positive rotating direction¹⁾.

-ns (off) = Switch-off speed at shaft rotation in negative rotating direction¹⁾.

Switching hysteresis \square :
5...100 % (factory setting = 10 % min. 1 Digit)

+ns (on) = Switch-on speed at shaft rotation in positive rotating direction¹⁾.

-ns (on) = Switch-on speed at shaft rotation in negative rotating direction¹⁾.

Absolute encoders - bus interfaces

Solid shaft $\varnothing 11$ mm with EURO flange B10 or housing foot B3

Profibus DPV0 or DPV2 / 13 bit ST / 16 bit MT / Speed switch

PMG10 - Profibus DP

Dimensions

Version with EURO flange B10

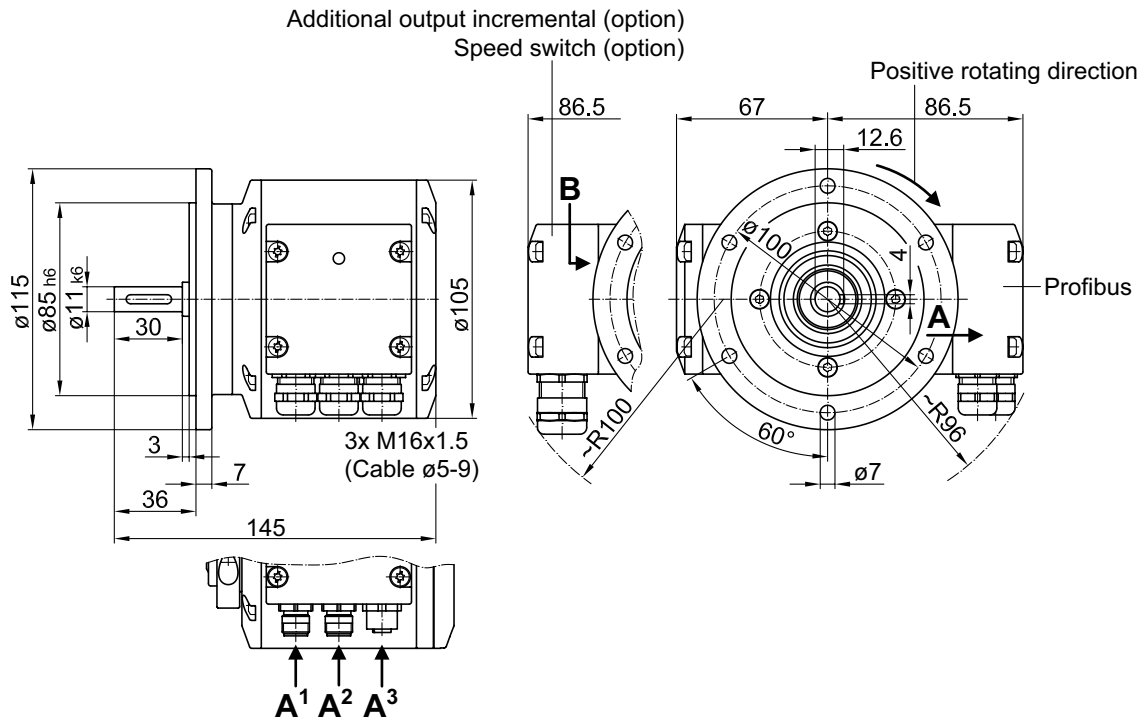

Version with housing foot B3

